



ANIMA[®]



UNAC
ASSOCIAZIONE COSTRUTTORI DI
INFISSI MOTORIZZATI E AUTOMATISMI
PER SERRAMENTI IN GENERE

Installer:

(Name, address, telephone)

**UNAC GUIDE No. 7
FOR THE INSTALLATION OF MOTORISED FLEXIBLE ROLLING AND VERTICAL FOLDING
DOORS**

**IN ACCORDANCE WITH MACHINERY DIRECTIVE 98/37/EEC AND THE APPLICABLE PARTS OF
STANDARDS EN 13241-1, EN 12453, EN 12445**

With this publication UNAC sets out to inform and assist installers in applying the specifications of the directives and of European standards concerning the safe use of motorised gates/doors.

It should be noted that those who sell and *motorise* an existing manual door/gate become the manufacturer of the motorised door/gate *machine* and must prepare and keep the technical file, as laid down by Annex V of the Machinery Directive (98/37/EEC). The technical file must contain the following documents:

- Assembly drawing of the motorised door/gate (usually included in the installation manual).
- Electrical connections and control circuit diagrams (usually included in the installation manual).
- Risk analysis including (as indicated on the following pages):
 - the list of the essential requirements as indicated in Annex I of the Machinery Directive;
 - the list of the risks presented by the door/gate and the description of the solutions adopted.
- They must also keep the manuals for installation and maintenance of the door/gate and of the components.
- Prepare the operating instructions and general warnings for safety (if necessary integrating those in the manual for installation of the door/gate) and give the user a copy.
- Compile the proof book and give the user a copy (see facsimile in Annex 1).
- Draft the EC declaration of conformity (see facsimile in Annex 2) and give the user a copy.
- Fill in the label or plate with CE marking and attach it to the motorised door/gate.

N.B. The technical file must be held and made available to the competent national authorities for at least ten years from the date of construction of the motorised door/gate.

Note also that, as from May 2005, the manufacturer of a new door/gate (both manual and motorised) must observe the procedure for the CE marking pursuant to the Construction Products Directive (89/106/EEC), as indicated in annex ZA of the standard EN 13241-1. This procedure involves the manufacturer:

- setting up and maintaining internal production control;
- having a notified body carry out the initial type tests referring to the applicable characteristics indicated in Annex ZA of standard EN 13241-1.

N.B. UNAC is preparing guidelines dedicated to the correct application of the Construction Products Directive (89/106/EEC).

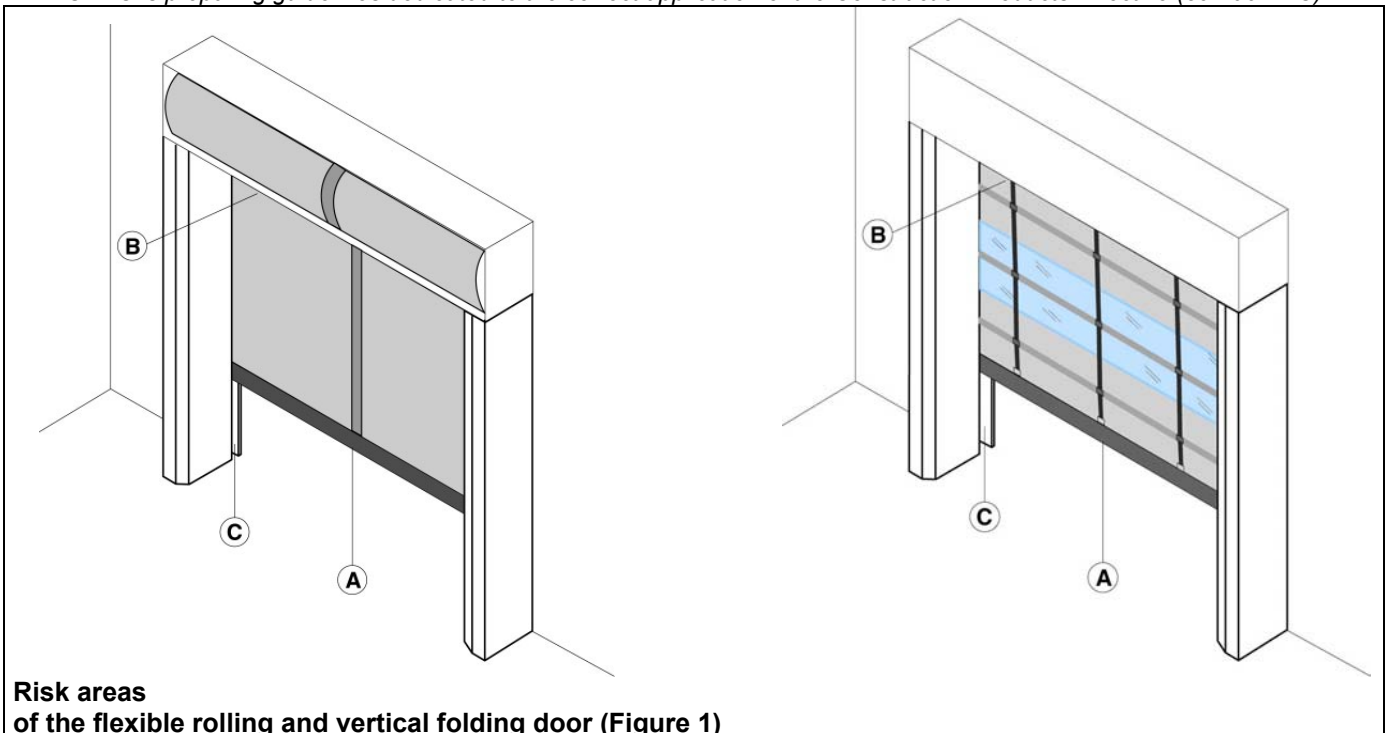

**Risk areas
of the flexible rolling and vertical folding door (Figure 1)**

The information given was drafted and checked with the utmost care, nevertheless UNAC declines all responsibility for any errors, omissions or inaccuracies due to technical or graphical requirements. UNAC points out that this guide does not replace the content of standards which the manufacturer of the motorised door/gate must observe.

KEY TO THE MECHANICAL RISKS CAUSED BY MOVEMENT

Pursuant to the Machinery Directive:

- “Danger zones” refer to any zone within and/or around machinery in which an exposed person is subject to a risk to his or her health and safety.
- “Exposed person” refers to any person wholly or partially in a danger zone.

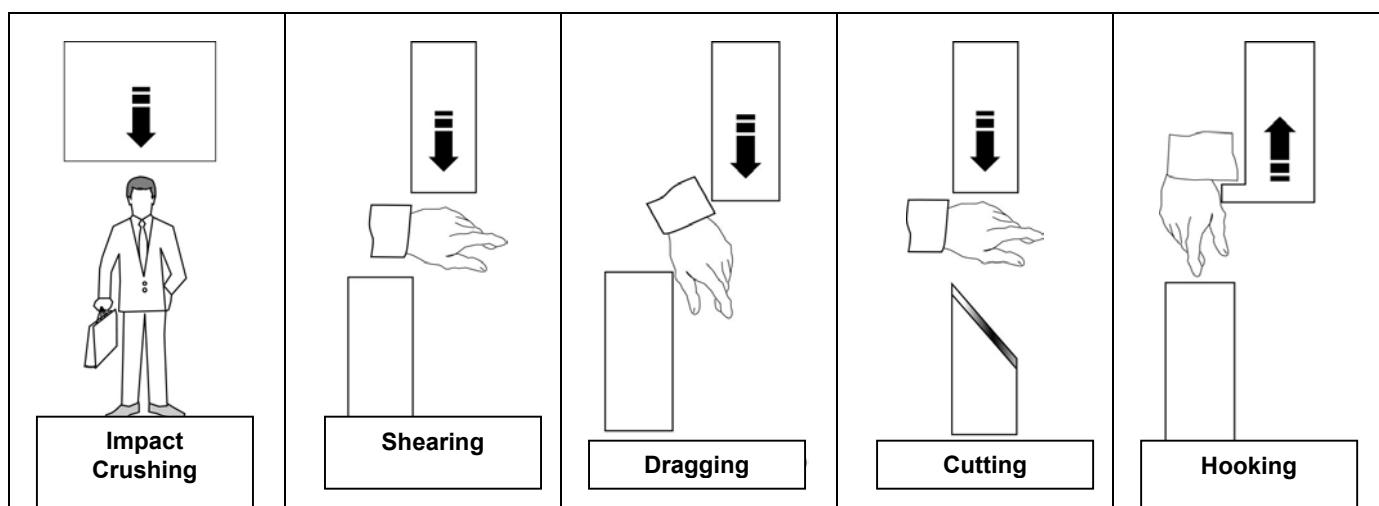

MINIMUM LEVEL OF PROTECTION OF THE MAIN EDGE

Type of actuation controls	Type of use		
	Informed users (private area)	Informed users (public area)	Uninformed users
Hold-to-run control	Pushbutton control	Pushbutton control with key	Hold-to-run control not possible
Impulse control with door visible	Limitation of forces, or presence sensing devices	Limitation of forces, or presence sensing devices	Limitation of forces and photocells, or presence sensing devices
Impulse control with door not visible	Limitation of forces, or presence sensing devices	Limitation of forces and photocells, or presence sensing devices	Limitation of forces and photocells, or presence sensing devices
Automatic control (e.g. timed closure control)	Limitation of forces and photocells, or presence sensing devices	Limitation of forces and photocells, or presence sensing devices	Limitation of forces and photocells, or presence sensing devices

ANALYSIS OF THE RISKS AND CHOICE OF SOLUTIONS

IN ACCORDANCE WITH THE MACHINERY DIRECTIVE 98/37/EEC AND THE STANDARDS EN 13241-1, EN 12453, EN 12445

The risks listed below follow the sequence of the installation process. These risks are those which are commonly present in motorised doors/gates systems. According to the various situations, consideration therefore has to be made of any possible additional risks and exclude those which are not applicable. The solutions to be adopted are those indicated by the standards mentioned above; in the case of risks not dealt with, the safety integration principles indicated by the Machinery Directive (Annex 1 – 1.1.2) have to be applied.

MD Ann. 1	Type of risks	Evaluation criteria and solutions to be adopted (Tick the box corresponding to the solution adopted)
1.3.1 1.3.2	<i>Mechanical, structural and wear risks.</i> [1] Loss of stability and break-up.	<input type="checkbox"/> Check the solidity of the structure installed (walls, architrave, etc.) in relation to the weight and forces generated by the motor. Attach the door stably using adequate materials. <input type="checkbox"/> If necessary, carry out the structural calculation and attach it to the Technical File. <input type="checkbox"/> Check that the possible breakage of the systems of suspension and/or balancing does not create hazardous situations, or the presence of anti-falling systems.
1.5.15	[2] Tripping.	<input type="checkbox"/> Check that any thresholds higher than 5 mm are visible, indicated or shaped.

MD Ann. 1	Type of risks	Evaluation criteria and solutions to be adopted (Tick the box corresponding to the solution adopted)
1.3.7 1.3.8 1.4	Mechanical risks caused by the movement of the gate (see references in Figure 1).	<input type="checkbox"/> CAUTION – If the door/gate is used solely with hold-to-run controls (and meets the requirements of the standard EN 12453), the danger points listed below do not have to be protected. <input type="checkbox"/> CAUTION – If protective devices are installed (in accordance with the standard EN 12978) which prevent in all cases contact between the moving leaf and persons (for example photoelectric barriers, presence sensing devices), it is not necessary to measure the operating forces.

[3] Impact and crushing on the lower closing edge (Figure 1, risk A).

Measure the closure forces (by means of the special instrument required by the standard EN 12445) as illustrated.
 Check that the values measured by the instrument are below those indicated in the graph.
 Carry out the measurements in the following points:
 L = 200 mm from the lateral edges and at mid-height;
 H = 50 mm,
 300 mm,
 and at maximum opening of the leaf minus 300 mm (max 2500).

N.B. The measurement should be repeated three times in each point and the average value considered.
 or

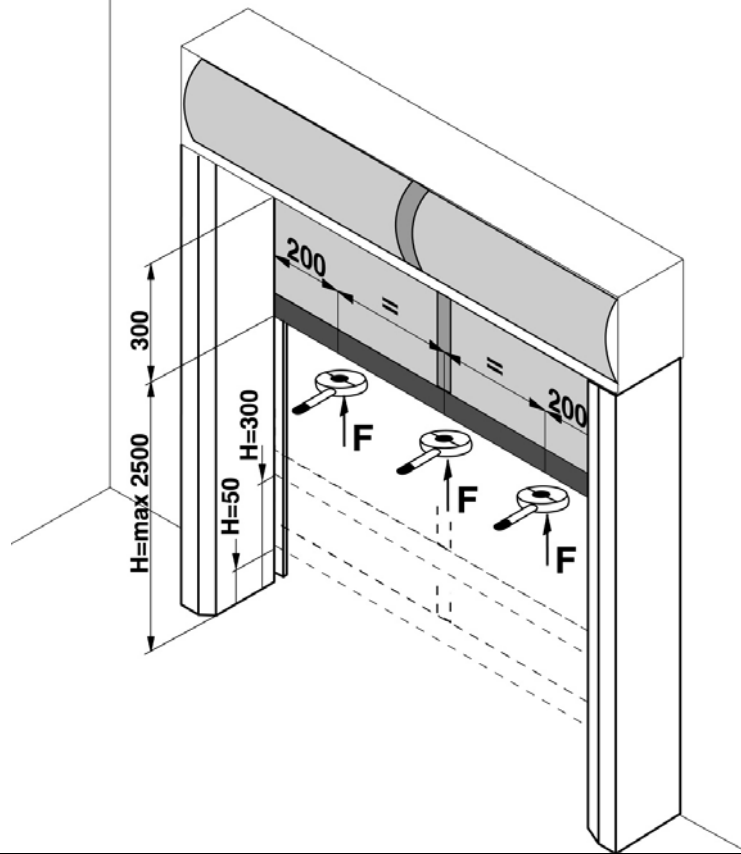



The graph indicates the maximum values of the dynamic, static and residual operating forces in relation to the various positions of the leaf.

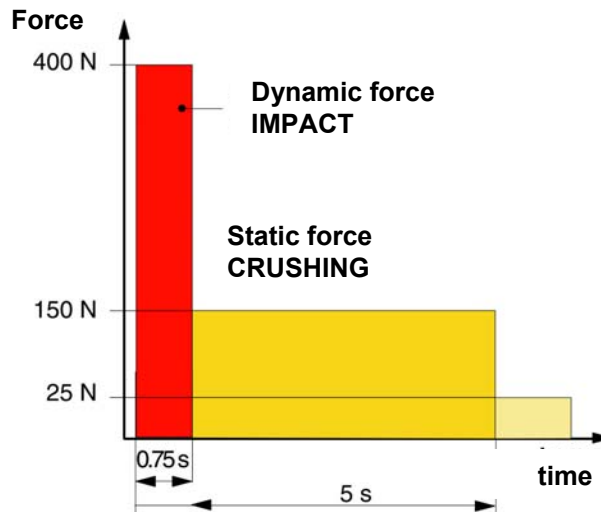

If the values of the forces are higher, install a protective device in accordance with the standard EN 12978 (for example a sensitive edge) and repeat the measurement.

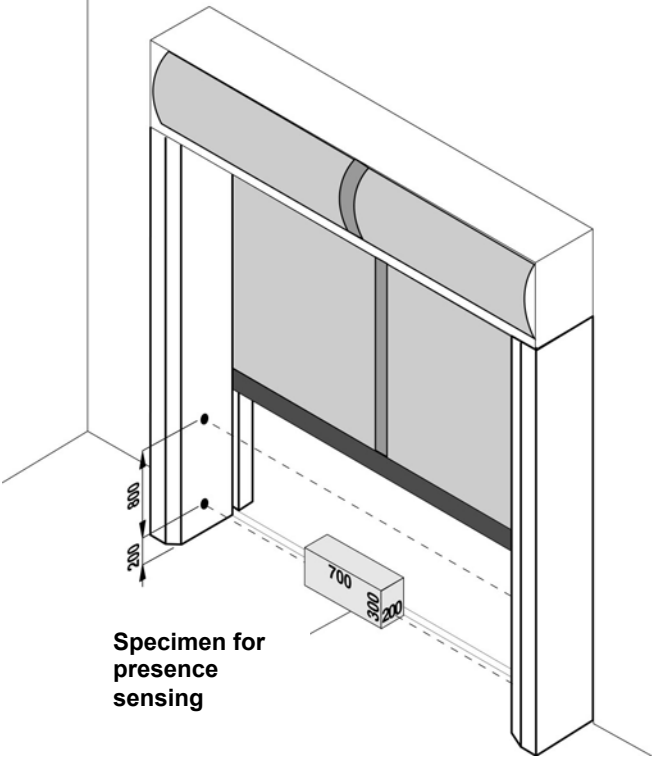
N. B. The dynamic force can be reduced, for example, by reducing the speed of the leaf or using a sensitive edge with high elastic deformation.



MD Ann. 1	Type of Risks	Evaluation criteria and solutions to be adopted (Tick the box corresponding to the solution adopted)
	<p>[4] Impact and crushing on the lower closing edge (Figure 1, risk A).</p> <p><input type="checkbox"/> Install a pair of photocells (recommended height 200 mm) so as to sense the presence of the test parallelepiped (height 300 mm), positioned as illustrated.</p> <p><input type="checkbox"/> To avoid impact with trucks and jeeps that are stopped in the transit area, a further pair of photocells should be installed at a height of 1000 mm.</p> <p><input type="checkbox"/> In the case of the thickness of the leaf being greater than 150 mm, to reduce further the possibility of impact in the area of closure of the shutter, an additional pair of photocells can be installed (recommended height 200 mm) on the opposite side.</p> <p><i>N.B. The test specimen for presence sensing is a parallelepiped (700 x 300 x 200 mm) having 3 faces with a light and reflective surface and 3 faces with a dark and opaque surface.</i></p>	 <p>The diagram shows a cross-section of a mobile leaf mechanism. A horizontal leaf is shown in a partially closed position. Two photocells are mounted on the leaf's edge, one at a height of 200 mm and another at 1000 mm. A test specimen, a parallelepiped with dimensions 700 mm by 300 mm by 200 mm, is positioned between the leaf and the photocells. The specimen is labeled 'Specimen for presence sensing'. The leaf's thickness is indicated as 150 mm.</p>
	<p>[5] Crushing, dragging and cutting on the secondary opening edge (Figure 1, risk B).</p> <p>[6] Danger of lifting.</p> <p>[7] Impact, crushing and cutting on the side slide guides of the mobile leaf (Figure 1, risk C)</p> <p>[8] Dragging, hooking and cutting due to shaping of the mobile leaf.</p>	<p><input type="checkbox"/> Check that the height of the opening space is > 2500 mm. or</p> <p><input type="checkbox"/> Attach protective devices that prevent the insertion of hands (e.g. a rubber strip).</p> <p><input type="checkbox"/> Check that the surface of the flexible leaf is smooth and therefore without hooking or cutting points; or</p> <p><input type="checkbox"/> Install protective devices that sense the presence of a person lifted by the leaf before reaching the danger zone (e.g. by installing one or more pairs of photocells); or</p> <p><input type="checkbox"/> Check that the door is not able to lift a weight of 20 kg (or 40 kg in the case of doors installed in private areas).</p> <p><input type="checkbox"/> The side slide guides (required for operation of the system) must have an opening reduced to a minimum in order to prevent insertion of hands, which must not come into contact with the leaf suspension systems (counterweights, belts, cables, chains etc.). The side slide guides must not have sharp edges.</p> <p><i>N.B. Insertion of the hands in the slide guides is however possible. It is preferable to attach the appropriate signs at the slide guides.</i></p> <p><input type="checkbox"/> Eliminate or protect any sharp edges, projecting parts etc. (for example by means of covers or strips in rubber).</p>

MD Ann. 1	Type of risks	Evaluation criteria and solutions to be adopted (Tick the box corresponding to the solution adopted)
1.5.1 1.5.2 1.5.10 1.5.11	<p><i>Electrical and electromagnetic compatibility risks.</i></p> <p>[9] Direct and indirect contacts. Dispersion of electrical energy.</p> <p>[10] Risks relating to electromagnetic compatibility.</p>	 <p><input type="checkbox"/> Use CE-marked components and materials pursuant to the Low Voltage Directive (73/23/EEC).</p> <p><input type="checkbox"/> Carry out the electrical connections, connection to the mains, earth connections and relevant checks, in accordance with current regulations and as indicated in the installation manual of the drive unit.</p> <p><i>N.B. If the electrical supply line is already set up (via both a socket and a connector block), declarations of conformity to Italian law no. 46/90 are not necessary.</i></p> <p><input type="checkbox"/> Use CE-marked components pursuant to the EMC Directive (89/336/EEC). Carry out the installation as indicated in the manual for installation of the drive unit.</p>
1.2 1.5.3 1.2.3 1.2.4	<p><i>Safety and reliability of drive unit and control and safety devices.</i></p> <p>[11] Safety conditions in the event of malfunctioning and power failure.</p> <p>[12] Energy types other than electrical energy</p> <p>[13] Actuation and disabling of the drive unit.</p> <p>[14] Power supply switch.</p>	<p><input type="checkbox"/> Use drive units which comply with the standard EN 12453 and safety devices which comply with the standard EN 12978.</p> <p><input type="checkbox"/> Check that the door does not perform hazardous movements (in the case of breakage of the suspension system, the door must not fall more than 300 mm).</p> <p><input type="checkbox"/> If hydraulic drive units are used, they must comply with the standard EN 982; or</p> <p><input type="checkbox"/> if pneumatic drive units are used, they must comply with the standard EN 983.</p> <p><input type="checkbox"/> Check that, after a fault or power failure, the drive unit restarts safely without creating hazardous situations.</p> <p><input type="checkbox"/> Install an omnipolar switch for electrical insulation of the door/gate, in accordance with current laws. This switch must be positioned and protected against accidental or unauthorised actuation.</p>
1.2.5 1.5.14 1.2.4	<p>[15] Consistency of controls</p> <p>[16] Risk of trapping.</p> <p>[17] Emergency stop.</p>	<p><input type="checkbox"/> Install the controls (e.g. key selector) so that the user is not in a danger zone, and check that the meaning of the controls has been understood by the user (for example the function selector).</p> <p><input type="checkbox"/> Use CE-marked radio controls pursuant to the R&TTE directive (1999/5/EEC) and complying with the frequencies admitted by the laws of each individual country.</p> <p><input type="checkbox"/> Install a device for release of the drive unit that allows manual opening and closure of the leaf with force no higher than 225 N (for doors/gates in residential areas) or 390 N (for doors/gates in industrial or commercial areas). Supply the user with the means and instructions for the release operations. Check that operation of the release device is simple and does not create additional risks.</p> <p><input type="checkbox"/> If appropriate, install an emergency stop control in accordance with the standard EN 418.</p> <p><i>N.B. Make sure that the emergency stop does not introduce additional risks, aborting operation of the safety devices installed.</i></p>

MD Ann. 1	Type of risks	Evaluation criteria and solutions to be adopted (Tick the box corresponding to the solution adopted)
1.7.1	<i>Integration principles for safety and information.</i> [18] Signalling equipment.	<input type="checkbox"/> A flashing light should be installed, in a visible position, to indicate movement of the leaf. <input type="checkbox"/> Traffic lights can be installed to control vehicle traffic. <input type="checkbox"/> Reflectors can also be attached to the leaf.
1.7.2	[19] Warnings.	<input type="checkbox"/> Attach all those signs or warnings considered necessary for indicating any unprotected residual risks and to indicate any foreseeable improper use.
1.7.3	[20] Marking.	<input type="checkbox"/> Attach the label or plate with the CE marking and containing what is indicated in Annex ZA of the standard EN 13241-1.. <div style="border: 1px solid black; padding: 10px; width: fit-content; margin: 0 auto;"> <div style="display: flex; justify-content: space-between; align-items: center;">  <div style="text-align: center;">Automatic Gate</div>  </div> <p>Manufacturer (name – address): _____</p> <p>Type of gate: _____</p> <p>Identification number: _____</p> <p>Year of manufacture: _____</p> </div>
1.7.4	[21] Operating instructions.	<input type="checkbox"/> Consign to the user the operating instructions, safety warnings and EC declaration of conformity (as indicated in Annex ZA of the standard EN 13241-1).
1.6.1	[22] Maintenance.	<input type="checkbox"/> A maintenance plan has to be drawn up and implemented. Check on the proper working of the safety devices at least every 6 months. <input type="checkbox"/> Record the work carried out in the proof book in accordance with the standard EN 12635 (cf. facsimile in Annex 1).
1.1.2	[23] Unprotected residual risks.	<input type="checkbox"/> Inform the user in writing (for example in the operating instructions) of any unprotected residual risks and foreseeable improper use.